

DESCRIPTION/APPLICATION

The Tri-Barrier product is an original Thomas & Betts design and we set new terminal block standards with its introduction. In recent years, some of our competition has copied this design.

It's easy to see why we're copied. Our Tri-Barrier blocks help contain stray or frayed wire ends. This prevents electrical shorts — not only between positions on the same block, but also between other components immediately adjacent to the block. With today's high-density PCB designs, this has become an increasingly important feature.

APPLICATIONS

- Industrial controls and automation
- Machine tools
- HVAC/R
- Power supplies
- Security/Irrigation
- Transformers

DESIGN ADVANTAGES

- Back barriers to safeguard field wiring
- Fast wiring – backed-out wire-ready screws
- Interrupted thread prevents screws from falling out
- Standoffs allow flux and solvents to drain during cleaning
- Molded-to-length or cut-to-length versions available
- Slotted or phil-slot screws available

# TRI-BARRIER STRIPS

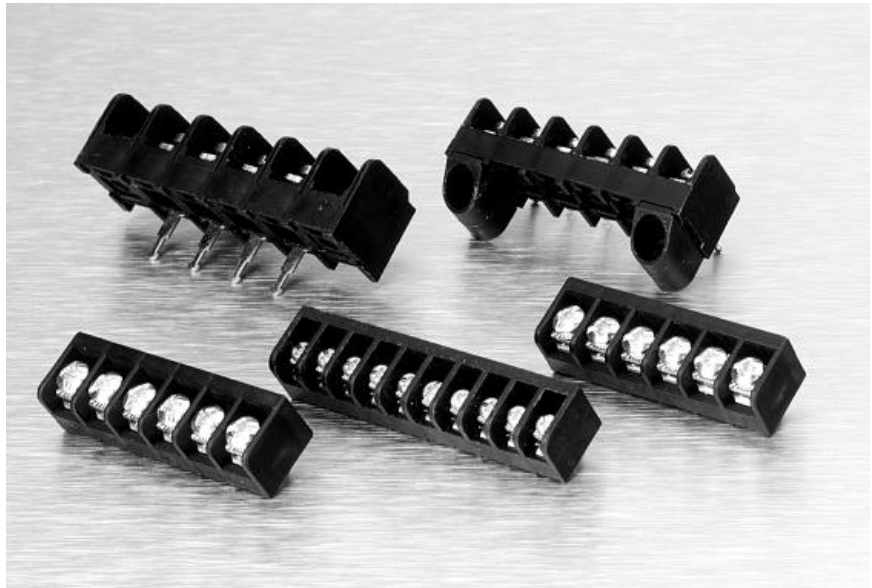

CONNECTOR INDEX		
0.250"	Pitch, Series #3.....	56-59
0.250"	Pitch, Series RSB2.....	60, 61
0.325"	Pitch, Series #4.....	62-65
0.325"	Pitch, Series RSB3.....	66-69
0.375"	Pitch, Series #6.....	70-73
0.375"	Pitch, Series RSB6.....	74-77
0.375"	Pitch, Series BC6, Panel Mount.....	78-79
0.375"	Pitch, Series MB6, Double Level.....	80, 81
0.4375"	Pitch, Series #8.....	82, 83

0.375" PITCH  
SERIES #6  
TRI-BARRIER

PHYSICAL PROPERTIES

HOUSING MATERIAL: Polyamide  
FLAMMABILITY: UL94V-0  
COLOR: Black

TERMINAL

TERMINALS: Bright acid tin over copper alloy  
SCREWS: #6-32 steel, zinc plating with clear chromate coating. Wire clamping screws standard. Binding head screw with undercut optional.

MECHANICAL

PITCH (TERMINAL SPACING): 0.375"  
RECOMMENDED PCB HOLE DIA.: 1.8mm (.073")

ELECTRICAL PROPERTIES

MAXIMUM CURRENT: 25A  
OPERATING VOLTAGE: 300V  
WIRE RANGE: 12-22 AWG

ENVIRONMENTAL PROPERTIES

OPERATING TEMPERATURE RANGE: 105°C max.

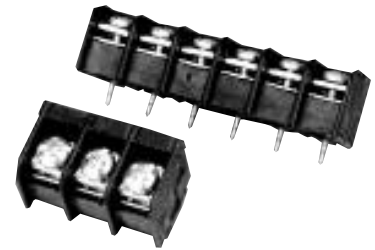

6PCV-03 & 6PCV-06

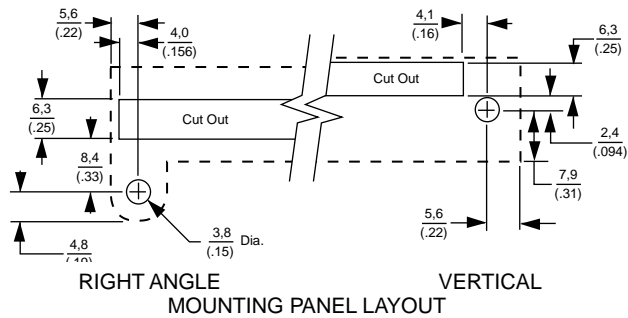
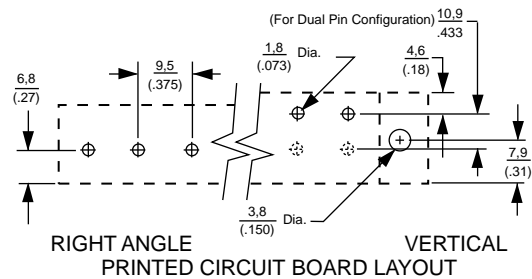

0.375" PITCH  
SERIES #6  
TRI-BARRIER

## 6 PCV-04-004

**A**      **B**      **C**      **D**

### ORDERING INFORMATION

**A** Screw Size Spacing  
6 = #6-32 on .375" Centers

**C** No. of Circuits (Not positions)  
02 through 30

**B** Terminal Style

- DBL = Double Printed Circuit Pin
- PCR = Printed Circuit, Right Angle
- PCV = Printed Circuit Pin, Vertical
- STR = Solder Turret, Right Angle
- STV = Solder Turret, Vertical
- TBV = Non Feed Thru (bottom covers required for all powered positions)
- WWR = Solderless Wire Wrap, Right Angle
- WWV = Solderless Wire Wrap, Vertical

**D** Modifiers

Use table below.  
Note: If modifier is -000  
it may be omitted. (6PCV-06)

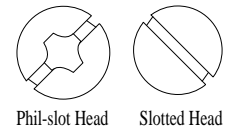

Model	Modifier		Screw Style	Mounting Construction
	Slotted Head	Phil-slot Head		
DBL	000	006	Wire Clamp	No Mounting
	001	007	Binding Head	
PCV	000	006	Wire Clamp	No Mounting
	001	007	Binding Head	
	004	008	Wire Clamp	
	005	009	Binding Head	
PCR	000	006	Wire Clamp	No Mounting
	001	007	Binding Head	
	004	008	Wire Clamp	
	005	009	Binding Head	
STV WWV	000	006	Wire Clamp	
	004	008	Wire Clamp	
STR WWR	000	006	Wire Clamp	
	004	008	Wire Clamp	
TBV	000	006	Wire Clamp	

0.375" PITCH  
SERIES #6  
TRI-BARRIER

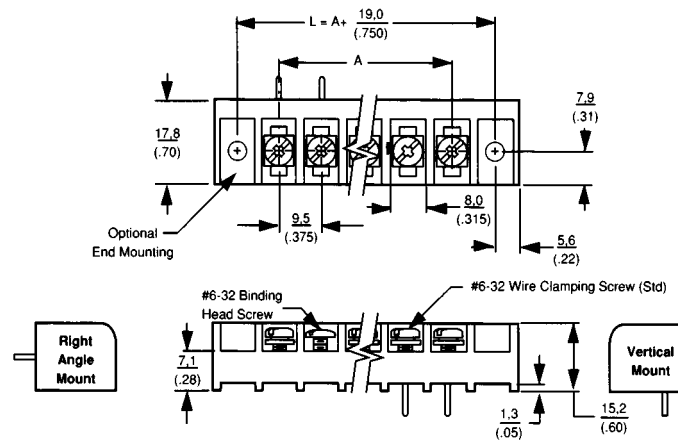

### Dimensions

TERMINALS	A	TERMINALS	A
2	(.375) 9,5	17	(6.00) 152,4
3	(0.75) 19,1	18	(6.37) 161,9
4	(1.12) 28,6	19	(6.75) 171,4
5	(1.50) 38,1	20	(7.12) 181,9
6	(1.87) 47,6	21	(7.50) 190,5
7	(2.25) 57,1	22	(7.87) 200,0
8	(2.62) 66,7	23	(8.25) 209,5
9	(3.00) 76,2	24	(8.62) 219,1
10	(3.37) 85,7	25	(9.00) 228,6
11	(3.75) 95,2	26	(9.38) 238,1
12	(4.12) 104,8	27	(9.75) 247,7
13	(4.50) 114,3	28	(10.13) 257,2
14	(4.87) 123,8	29	(10.50) 266,7
15	(5.25) 133,3	30	(10.88) 276,2
16	(5.62) 142,9		

0.375" PITCH  
SERIES #6  
TRI-BARRIER

Printed Circuit Pin

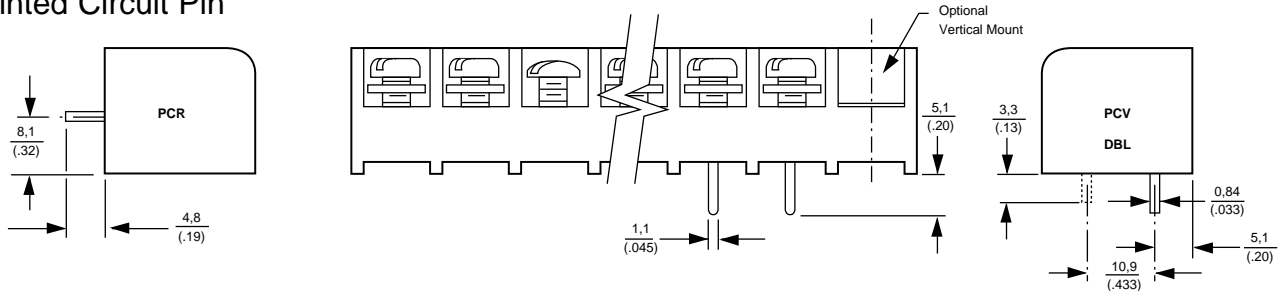

Solder Turret

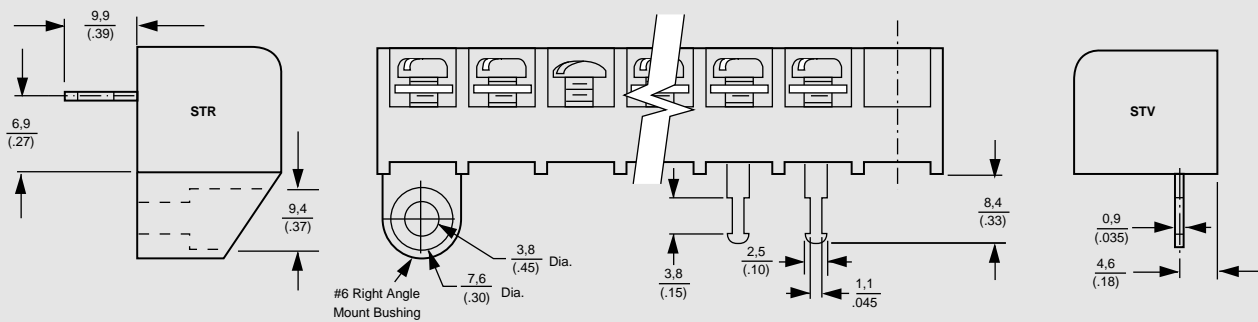

Wire Wrap

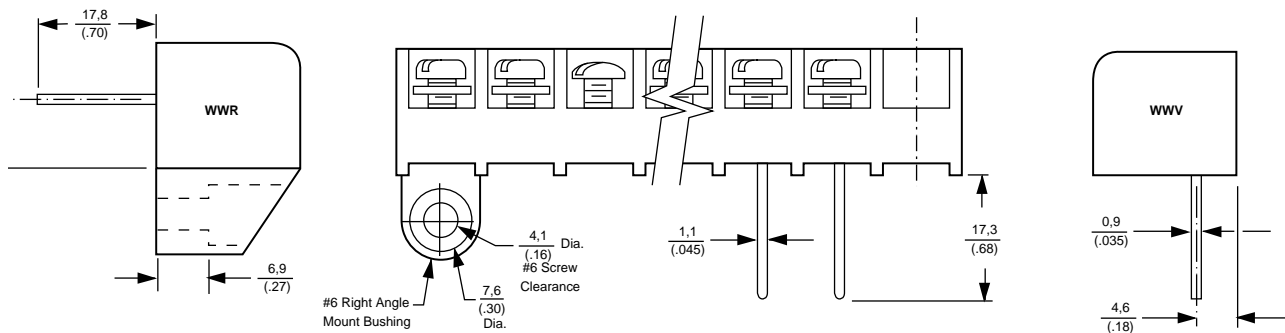

Non-Feed Thru

